

A photograph of a wooden table and a wicker chair on a wooden deck. The table is made of light-colored wood with a slatted top. The chair is made of light-colored wicker with a white cushion. The deck is made of light-colored wood with a horizontal grain. The text "WoodEvo." is overlaid in the top left corner.

# WoodEvo.

## DECKING, CLADDING, BATTENS PRODUCT GUIDE

# WoodEvo.

## WHO WE ARE

At WoodEvo, our mission is clear and simple—wood, evolved. We're dedicated to crafting stylish, durable, and low-maintenance decking, cladding, and batten solutions specifically tailored for Australian homes and lifestyles. Understanding the challenges of Australia's climate, we've designed our products to handle intense sun, harsh weather, and everyday life without compromising on affordability or quality.

Our thoughtfully designed ranges provide homeowners and professionals alike with versatile choices, from the modern aesthetics and easy installation of our cladding and battens, to decking solutions featuring innovative cooling technologies, superior slip-resistance, and exceptional durability. WoodEvo's commitment to sustainability and quality is reflected through our industry-leading certifications, including Codemark and GreenTag. With extensive warranties backing each product, you can confidently create beautiful, functional outdoor spaces that will stand the test of time.

Welcome to the WoodEvo community—where quality, innovation, and style come together seamlessly.

*Leanne Kelly*

Leanne Kelly  
National Sales Manager



Global GreenTag  
Certified on HOME  
Decking Range &  
CLADDING.



**CODEMARK**  
Australia  
CM70164, CM70187, CM70209

CodeMark Certified  
across our HOME,  
ADVANCED, and  
CLADDING ranges.



# HOME

## Wood-Plastic Composite (WPC)

Stylish, affordable, and family-friendly. Crafted from quality timber fibres and recycled plastics, HOME's unique M-shape profile stays cooler underfoot. Extra-thick HDPE capping provides scratch and fade resistance, while the R11 slip rating ensures safety around pools and ramps.

### BOARD INFORMATION:

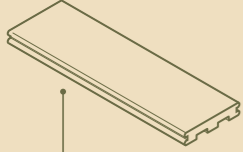
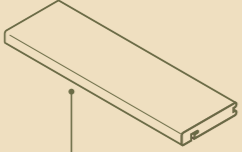
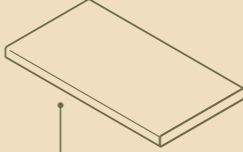
 GROOVED BOARDS Dimensions: 138mm x 23mm	 EDGE BOARDS Dimensions: 138mm x 23mm	 FASCIA BOARDS Dimensions: 180mm x 15mm
---	---	--

 BASALT	 SNOW WHITE
 BAROSSA	 TALLOWWOOD
 CHARCOAL	 TEAK
 HAMPTON	 VIC ASH
 NORDIC	



25  
YEAR  
WARRANTY

Wood. Evolved.

# ADVANCED

ADVANCED140 VICTORIAN MAPLE

## Foamed PVC Composite

Premium performance meets designer style. Made from 100% wood-free foamed PVC for superior stability and coolness underfoot. Featuring ASA capping for unmatched fade, scratch, and abrasion resistance, plus Australia's highest slip rating (P5/R13). Perfect for residential and commercial projects.

### BOARD INFORMATION:

#### ADVANCED140

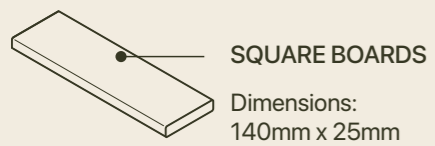
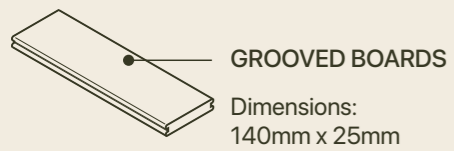

#### ADVANCED200

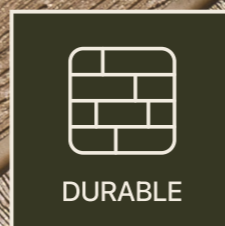
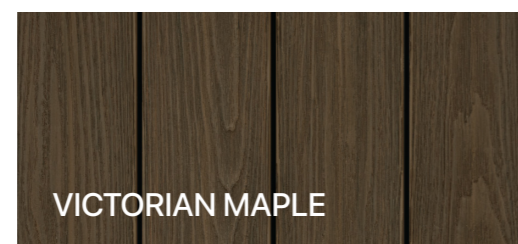
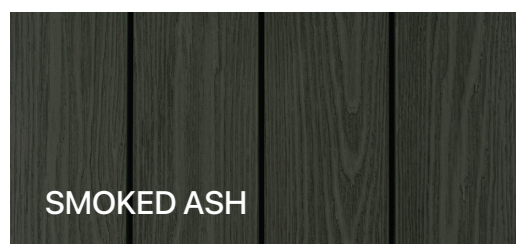
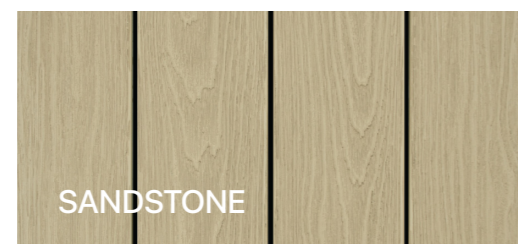
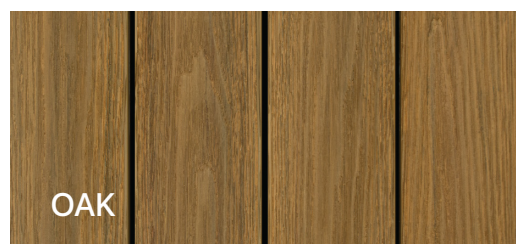
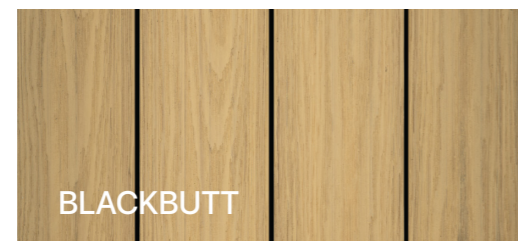
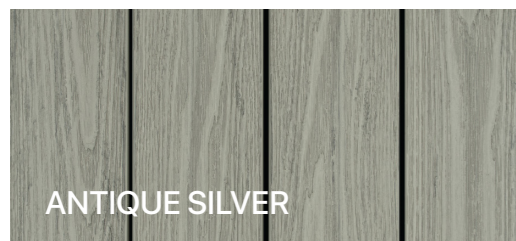
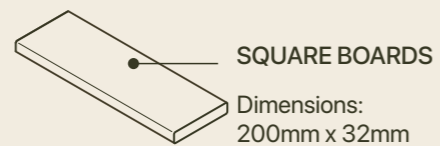
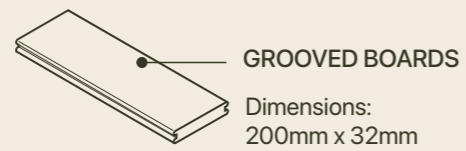

30  
YEAR  
WARRANTY

Wood. Evolved.

HOME TALLOWWOOD



ADVANCED OAK





HOME SNOW WHITE



ADVANCED140 SANDSTONE



HOME VIC ASH



ADVANCED140 SMOKED ASH

# CLADDING

## Wood-Plastic Composite (WPC)

Bring a bold, architectural edge to any space with WoodEvo's Cladding range. Made from durable wood-plastic composite, it's designed to deliver a modern, low-maintenance finish for facades, screens, and feature walls.

### BOARD INFORMATION:

#### Deep Castellation Cladding



Width: 216mm  
Cover: 186mm  
Thickness: 33mm  
Length: 2900 | 3600 | 4200mm



BEACH

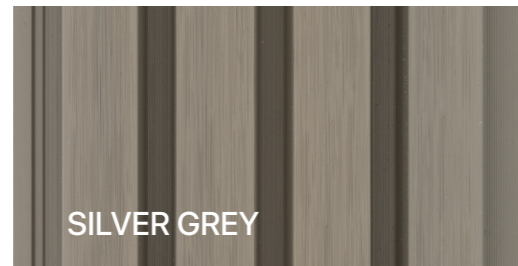

SILVER GREY

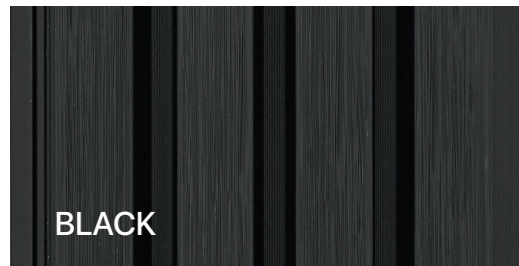

BLACK



WHITE

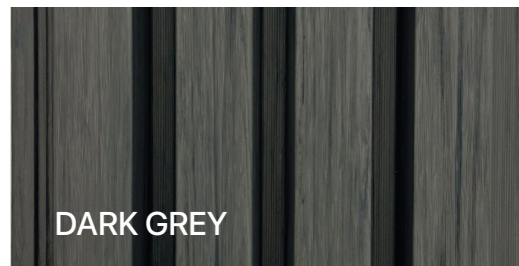

DARK GREY

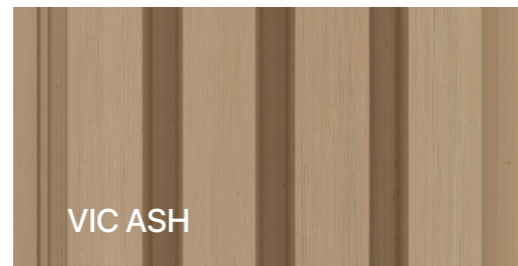

VIC ASH

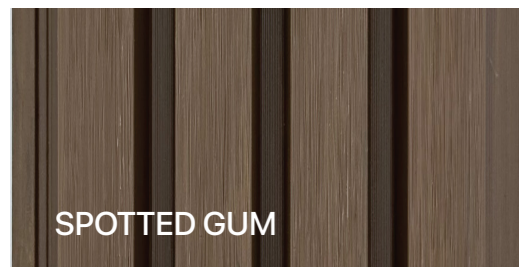

SPOTTED GUM

CLADDING DARK GREY



12  
YEAR  
WARRANTY

Wood. Evolved.

# BATTEN

## Foamed PVC Composite

Crafted from durable foamed PVC composite with a UV and scratch-resistant ASA capping, our battens offer the natural look of timber without the upkeep. No staining, oiling, or repainting needed. Backed by a 30-year warranty, they're perfect for fencing, screening, and stylish outdoor features.

### BOARD INFORMATION:

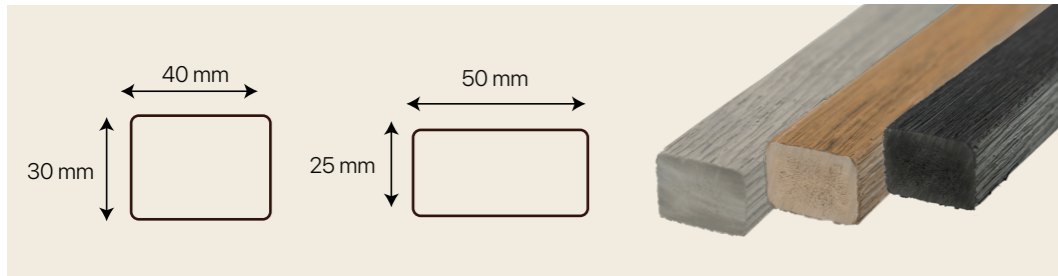

ANTIQUE SILVER



BLACKBUTT



OAK

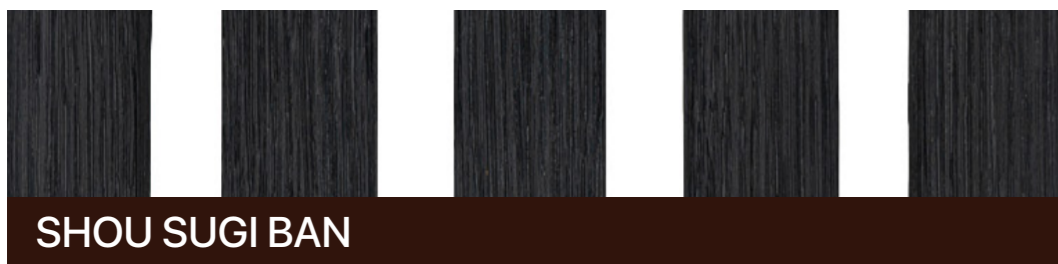

SHOU SUGI BAN



LIGHTWEIGHT

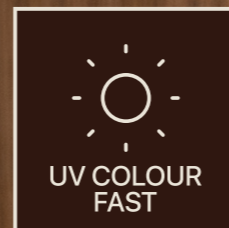

UV COLOUR  
FAST



NATURAL  
GRAIN

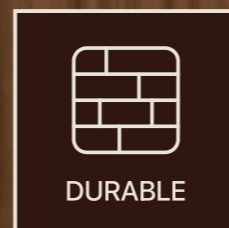

DURABLE

30  
YEAR  
WARRANTY

BATTEN OAK

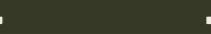
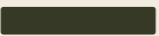

# TECHNICAL SPECIFICATIONS

Board Type	Decking Material	Board Profile	Dimensions	Length	QTY/Pack
<b>HOME</b>					
Grooved Board	Wood-Plastic Composite		138mm x 23mm	5.4m	70/Pack
Edge Board	Wood-Plastic Composite		138mm x 23mm	5.4m	70/Pack
Fascia Board	Wood-Plastic Composite		180mm x 15mm	5.4m	64/Pack
<b>ADVANCED</b>					
Grooved Board	Foamed PVC Composite		140mm x 25mm	5.4m	70/Pack
	Foamed PVC Composite		200mm x 32mm	3.6m	70/Pack
Square Board	Foamed PVC Composite		140mm x 25mm	5.4m	70/Pack
	Foamed PVC Composite		200mm x 32mm	3.6m	70/Pack

Residential Span	Commercial Span	Slip Rating	BAL Rating	Can be Pressure Washed?	Certifications
Available Colours: Barossa, Basalt, Charcoal, Hampton, Nordic, Tallowwood, Teak, Snow White, Vic Ash					
450mm	350mm	R11	BAL29	Yes	CodeMark No. CM70164 GreenTag Cert: GreenRate Level B
450mm	350mm	R11	BAL29	Yes	CodeMark No. CM70164 GreenTag Cert: GreenRate Level B
450mm	350mm	R11	BAL29	Yes	CodeMark No. CM70164 GreenTag Cert: GreenRate Level B
Available Colours: Antique Silver, Blackbutt, Oak, Sandstone, Smoked Ash, Victorian Maple					
400mm	350mm	R13/P5	BAL29	Yes	CodeMark No. CM70187
450mm	450mm	R13/P5	BAL29	Yes	CodeMark No. CM70187
400mm	350mm	R13/P5	BAL29	Yes	CodeMark No. CM70187
450mm	450mm	R13/P5	BAL29	Yes	CodeMark No. CM70187

Board Type	Cladding Material	Board Profile	Dimensions	Length	QTY/Pack
<b>CLADDING</b>					
Deep Castellated	Wood-Plastic Composite		219mm x 33mm	2.9m 3.6m 4.2m	80/Pack

Coverage	Span	BAL Rating	Can be Pressure Washed?	Certifications
Available Colours: Beach, Black, Dark Grey, Silver Grey, Spotted Gum, Vic Ash, White				
186mm	500mm	BAL29	Yes	CodeMark No. CM70209 GreenTag Cert: GreenRate Level B

Board Type	Batten Material	Board Profile	Dimensions	Length	QTY/Pack
<b>BATTEN</b>					
Batten	Foamed PVC Composite		50mm x 25mm	5.4m	196/Pack
Batten	Foamed PVC Composite		40mm x 30mm	5.4m	216/Pack

Weight	Span	Can be Pressure Washed?	Certifications
Available Colours: Antique Silver, Blackbutt, Oak, Shou Sugi Ban			
8.55kg	600mm	Yes	NIL
10.62kg	600mm	Yes	NIL

# HOW TO ORDER

## 1. SEE THE BOARDS

You can request free samples online, or even better, see larger displays at a local showroom. This will give you a great idea of what your WoodEvo deck will look like.

## 2. GET A QUOTE

### Supply & install

Head over to the 'Installers' page on the WoodEvo website. You'll find a list of Accredited Installers in your area who can organise a free on-site measure & quote. Your installer will handle everything and give advice on design options such as seats, stairs, curves and more.

### Materials only

Check out the 'Where to Buy' page on the WoodEvo website. You'll find a list of stores who stock WoodEvo and can provide pricing for your project.



## WHERE TO BUY?

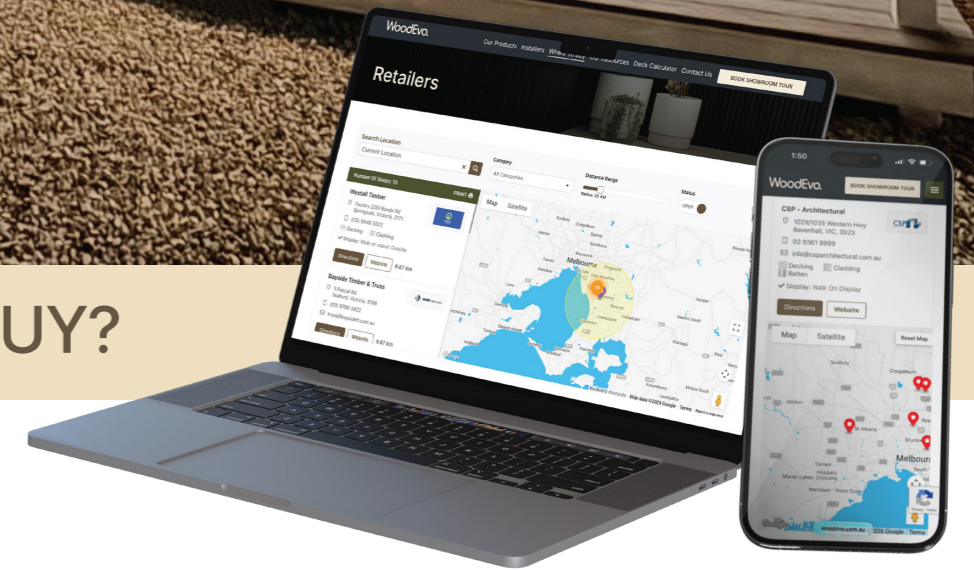

68+ locations | Full display details | Decking. Cladding. Battens.



Trusted brand Global  
Greentag Certified  
Level B. License No:  
WVO:CN01:2025:GR.



WoodEvo is CodeMark  
certified: HOME  
(CM70164), ADVANCED  
(CM70187) & CLADDING  
(CM70209).

### RETAILERS



### FREE SAMPLE



### DECK CALCULATOR



# FAQ

## DECKING

### How does WoodEvo perform on hot days in full sun?

WoodEvo stays cooler underfoot. HOME uses an 'M' profile and hardwood fibres for better heat control. ADVANCED offers superior cooling with a foamed PVC core and ASA capping for thermal insulation.

### How slip resistant is WoodEvo? Is it suitable around pools?

Yes. HOME is R11-rated, suitable for ramps. ADVANCED leads with P5 and R13 ratings, ideal for wet and poolside areas.

### How scratch resistant is WoodEvo? Is it suitable for homes with pets?

Absolutely. HOME uses HDPE capping for durability. ADVANCED features flexible ASA capping to reduce scratches from active pets.

### Do I have to use an accredited installer or can I use my own tradie, or DIY?

Yes. DIY or any tradie is fine, as long as installation guidelines are followed to maintain warranty. Accredited installers are recommended for best results.

### Does WoodEvo fade?

No. HOME has UV inhibitors and a 25-year fade warranty. ADVANCED uses ASA capping with a 30-year fade warranty for superior sun resistance.

## CLADDING

### Can I DIY the cladding?

Yes. It's lightweight and easy to install. Guide available online.

### Is it sustainable and certified?

Yes. GreenTag certified for health, environment, and responsible sourcing.

### Is it weather-resistant?

Yes. Resists UV, moisture, fading, and scratches—ideal for long-term external use.

### Can it be installed on existing walls?

Yes. Designed for both new and existing structures, with a concealed fixing system for a clean finish.

### Does WoodEvo CLADDING come with a warranty?

Yes! Backed by a 12-year warranty, covering structural integrity, resistance to fading, staining, warping, and splitting.

## BATTEN

### Can WoodEvo Battens be installed as a DIY project?

Yes. WoodEvo BATTEN is DIY-friendly with an online installation guide.

### Are WoodEvo Battens suitable for coastal or high-humidity areas?

Yes. They resist moisture, salt, and weather with zero organic content, offering better stability than timber or WPC.

### Is there a warranty?

Yes. 30-year warranty covers resistance to mold, mildew, rot, fading, staining and splitting. Full terms on our website.

### Is it easy to cut and install?

Very. Cut with an aluminium blade. Install with visible screws or hidden plugs for a seamless look.





# THE NEW ALUMINIUM TRIM SYSTEM



Colour matched to our **CLADDING** colours  
 Beach, Black, Dark Grey, Silver Grey, Spotted Gum, Vic Ash, White



## INSTALLATION GUIDE

Ready to get started? Scan the QR codes to grab our installation guides and follow easy step-by-step instructions created to make your install smooth and stress-free.



HOME INSTALL



ADVANCED INSTALL



CLADDING INSTALL



BATTEN INSTALL

## QUICKLOCK CLIP SYSTEM



Internal Metal Plate for durability

30%  
QUICKER TO INSTALL!



# WoodEvo.

Designed for  
Australian Conditions &  
**Proudly Australian Owned**

WoodEvo is available Australia Wide. Due to printing restraints, variation in lighting and the goal of recreating the variations seen in natural timber, actual colours may vary from those shown. Products, colours and sizes may change without notice. This publication may not be reproduced or copied without written permission from © 2026 NaturalTech Pty Ltd.